

# NCP3985

## Micropower, 150 mA Low-Noise, High PSRR, Ultra-Low Dropout BiCMOS Voltage Regulator

The NCP3985 is 150 mA LDO that provides the engineer with a very stable, accurate voltage with low noise and high Power Supply Rejection Ratio (PSRR) suitable for sensitive applications. In order to optimize performance for battery operated portable applications, the NCP3985 employs an advanced BiCMOS process to combine the benefits of low noise and superior dynamic performance of bipolar elements with very low ground current consumption at full loads offered by CMOS.

The NCP3985 is stable with small, low value capacitors and is available in TSOP-5 package.

### Features

- Output Voltage Options:
  - 1.8 V, 2.5 V, 2.75 V, 2.8 V, 3.0 V, 3.3 V
  - Contact Factory for Other Voltage Options
- Output Current Limit 200 mA
- Low Noise (typ 20  $\mu\text{V}_{\text{rms}}$ )
- High PSRR (typ 70 dB)
- Stable with Ceramic Output Capacitors as low as 1  $\mu\text{F}$
- Low Sleep Mode Current (max 1  $\mu\text{A}$ )
- Active Discharge Circuit
- Current Limit Protection
- Thermal Shutdown Protection
- Direct Replacement for LP3985
- These are Pb-Free Devices

### Typical Applications

- Cellular Telephones
- Noise Sensitive Applications (Video, Audio)
- Analog Power Supplies
- PDAs / Palmtops / Organizers / GPS
- Battery Supplied Devices

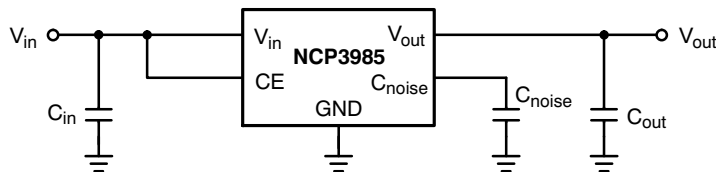

Figure 1. Typical Application Schematic



ON Semiconductor®

<http://onsemi.com>



TSOP-5  
SN SUFFIX  
CASE 483

### MARKING DIAGRAM

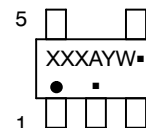

XXX = Specific Device Code  
A = Assembly Location  
Y = Year  
W = Work Week  
▪ = Pb-Free Package

(Note: Microdot may be in either location)

### PIN ASSIGNMENT

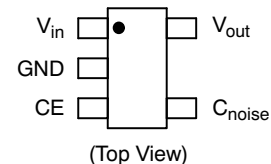

### ORDERING INFORMATION

See detailed ordering, marking and shipping information in the package dimensions section on page 9 of this data sheet.

# NCP3985

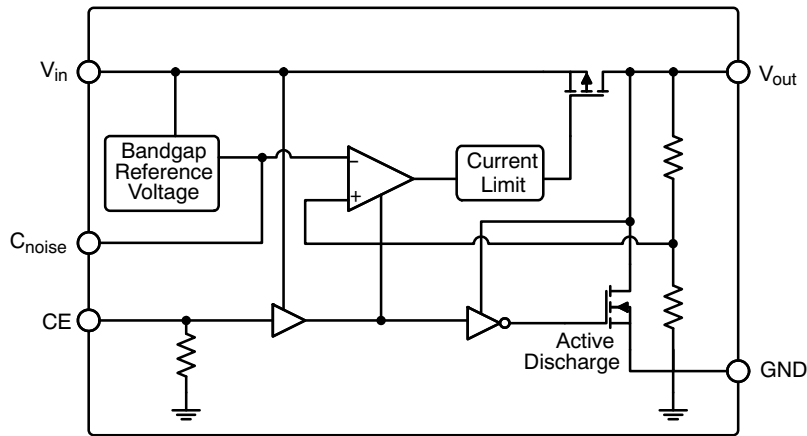

Figure 2. Simplified Block Diagram

## PIN FUNCTION DESCRIPTION

Pin No.	Pin Name	Description
1	$V_{in}$	Power Supply Input Voltage
2	GND	Power Supply Ground
3	CE	Chip Enable: This pin allows on/off control of the regulator. To disable the device, connect to GND. If this function is not in use, connect to $V_{in}$ . Internal 5 M $\Omega$ Pull Down resistor is connected between CE and GND.
4	$C_{noise}$	Noise reduction pin. (Connect 100 nF or 10 nF capacitor to GND)
5	$V_{out}$	Regulated Output Voltage

## MAXIMUM RATINGS

Rating	Symbol	Value	Unit
Input Voltage (Note 1)	$V_{in}$	-0.3 V to 6 V	V
Chip Enable Voltage	$V_{CE}$	-0.3 V to $V_{in} + 0.3$ V	V
Noise Reduction Voltage	$V_{Cnoise}$	-0.3 V to $V_{in} + 0.3$ V	V
Output Voltage	$V_{out}$	-0.3 V to $V_{in} + 0.3$ V	V
Maximum Junction Temperature (Note 1)	$T_{J(max)}$	150	$^{\circ}$ C
Storage Temperature Range	$T_{STG}$	-55 to 150	$^{\circ}$ C

Stresses exceeding Maximum Ratings may damage the device. Maximum Ratings are stress ratings only. Functional operation above the Recommended Operating Conditions is not implied. Extended exposure to stresses above the Recommended Operating Conditions may affect device reliability.

NOTE: This device series contains ESD protection and exceeds the following tests:  
 Human Body Model 2000 V per MIL-STD-883, Method 3015  
 Machine Model Method 200 V

## THERMAL CHARACTERISTICS

Rating	Symbol	Value	Unit
Package Thermal Resistance: (Note 1) Junction-to-Lead (pin 5) Junction-to-Ambient	$R_{\theta JA}$	109 220	$^{\circ}$ C/W

1. Refer to ELECTRICAL CHARACTERISTICS and APPLICATION INFORMATION for Safe Operating Area

# NCP3985

## ELECTRICAL CHARACTERISTICS

( $V_{in} = V_{out} + 0.5\text{ V}$ ,  $V_{CE} = 1.2\text{ V}$ ,  $C_{in} = 0.1\text{ }\mu\text{F}$ ,  $C_{out} = 1\text{ }\mu\text{F}$ ,  $C_{noise} = 10\text{ nF}$ ,  $T_A = -40^\circ\text{C}$  to  $85^\circ\text{C}$ , unless otherwise specified (Note 2))

Characteristic	Test Conditions	Symbol	Min	Typ	Max	Unit
<b>REGULATOR OUTPUT</b>						
Input Voltage		$V_{in}$	2.5	-	5.5	V
Output Voltage (Note 3)	$V_{in} = (V_{out} + 0.5\text{ V})$ to $5.5\text{ V}$ $I_{out} = 1\text{ mA}$	$V_{out}$	1.764 2.450 2.695 2.744 2.940 3.234 (-2%)	- - - - - -	1.836 2.550 2.805 2.856 3.060 3.366 (+2%)	V
Output Voltage (Note 3)	$V_{in} = (V_{out} + 0.5\text{ V})$ to $5.5\text{ V}$ $I_{out} = 1\text{ mA}$ to $150\text{ mA}$	$V_{out}$	1.746 2.425 2.6675 2.716 2.910 3.201 (-3%)	- - - - - -	1.854 2.575 2.8325 2.884 3.090 3.399 (+3%)	V
Power Supply Ripple Rejection	$V_{in} = V_{out} + 0.5\text{ V} + 0.5\text{ V}_{p-p}$ $I_{out} = 1\text{ mA}$ to $150\text{ mA}$ $f = 120\text{ Hz}$ $C_{noise} = 100\text{ nF}$ $f = 1\text{ kHz}$ $f = 10\text{ kHz}$	PSRR	- - -	70 70 55	- - -	dB
Line Regulation	$V_{in} = (V_{out} + 0.5\text{ V})$ to $5.5\text{ V}$ , $I_{out} = 1\text{ mA}$	$Reg_{line}$	-0.2	-	0.2	%/V
Load Regulation	$I_{out} = 1\text{ mA}$ to $150\text{ mA}$	$Reg_{load}$	-	12	25	mV
Output Noise Voltage	$f = 10\text{ Hz}$ to $100\text{ kHz}$ $I_{out} = 1\text{ mA}$ to $150\text{ mA}$ $C_{noise} = 100\text{ nF}$ $C_{noise} = 10\text{ nF}$	$V_n$	- -	20 25	- -	$\mu\text{V}_{rms}$
Output Current Limit	$V_{out} = V_{out(nom)} - 0.1\text{ V}$	$I_{LIM}$	200	310	470	mA
Output Short Circuit Current	$V_{out} = 0\text{ V}$	$I_{SC}$	210	320	490	mA
Dropout Voltage (Note 4)	$I_{out} = 150\text{ mA}$	$V_{DO}$	- - - - -	105 105 105 100 100	155 155 155 150 150	mV

## GENERAL

Ground Current	$I_{out} = 1\text{ mA}$ $I_{out} = 150\text{ mA}$	$I_{GND}$	- -	70 110	90 220	$\mu\text{A}$
Disable Current	$V_{CE} = 0\text{ V}$	$I_{DIS}$	-	0.1	1	$\mu\text{A}$
Thermal Shutdown Threshold (Note 5)		$T_{SD}$	-	150	-	$^\circ\text{C}$
Thermal Shutdown Hysteresis (Note 5)		$T_{SH}$	-	20	-	$^\circ\text{C}$

## CHIP ENABLE

Input Threshold	Low High	$V_{th(CE)}$	- 1.2	- -	0.4 -	V
Internal Pull-Down Resistance (Note 6)		$R_{PD(CE)}$	2.5	5	10	$\text{M}\Omega$

## TIMING

Turn-on Time	$I_{out} = 150\text{ mA}$ $C_{noise} = 10\text{ nF}$ $C_{noise} = 100\text{ nF}$	$t_{on}$	- -	0.4 4	- -	ms
Turn-off Time	$C_{noise} = 10\text{ nF}/100\text{ nF}$ $I_{out} = 1\text{ mA}$ $I_{out} = 10\text{ mA}$	$t_{off}$	- -	800 200	- -	$\mu\text{s}$

- Performance guaranteed over the indicated operating temperature range by design and/or characterization, production tested at  $T_J = T_A = 25^\circ\text{C}$ . Low duty cycle pulse techniques are used during testing to maintain the junction temperature as close to ambient as possible.
- Contact factory for other voltage options.
- Measured when output voltage falls 100 mV below the regulated voltage at  $V_{in} = V_{out} + 0.5\text{ V}$  if  $V_{out} < 2.5\text{ V}$ , then  $V_{DO} = V_{in} - V_{out}$  at  $V_{in} = 2.5\text{ V}$ .
- Guaranteed by design and characterization.
- Expected to disable device when CE pin is floating.

TYPICAL CHARACTERISTICS

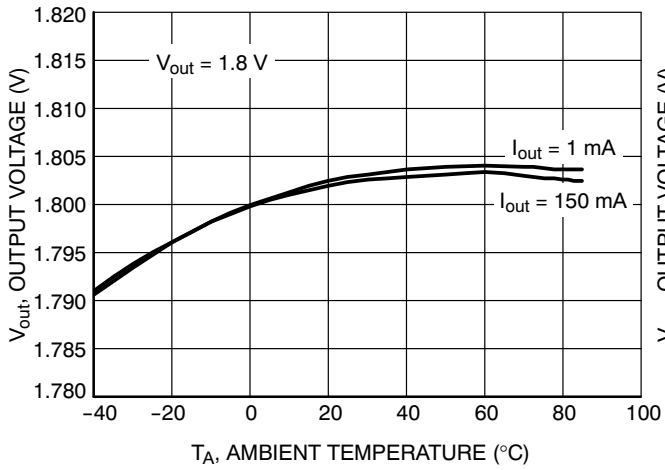

Figure 3. Output Voltage vs. Temperature  
( $V_{out} = 1.8\text{ V}$ )

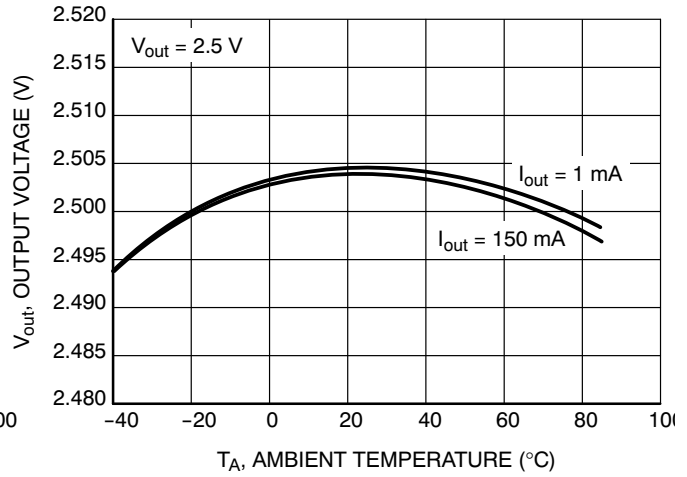

Figure 4. Output Voltage vs. Temperature  
( $V_{out} = 2.5\text{ V}$ )

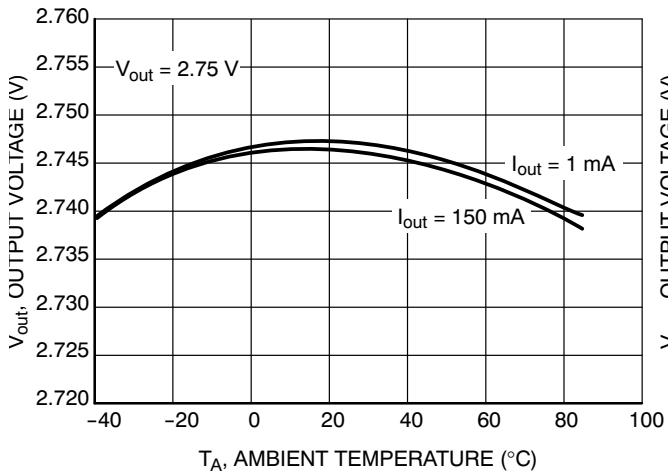

Figure 5. Output Voltage vs. Temperature  
( $V_{out} = 2.75\text{ V}$ )

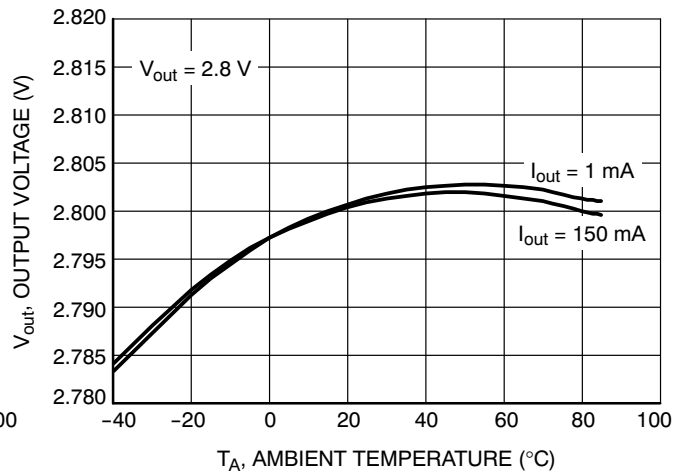

Figure 6. Output Voltage vs. Temperature  
( $V_{out} = 2.8\text{ V}$ )

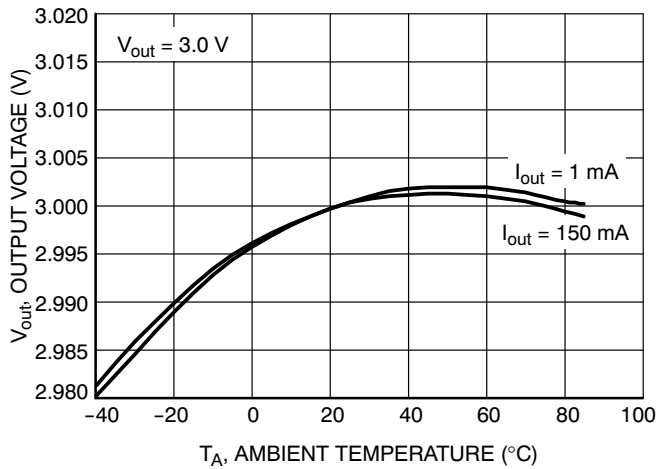

Figure 7. Output Voltage vs. Temperature  
( $V_{out} = 3.0\text{ V}$ )

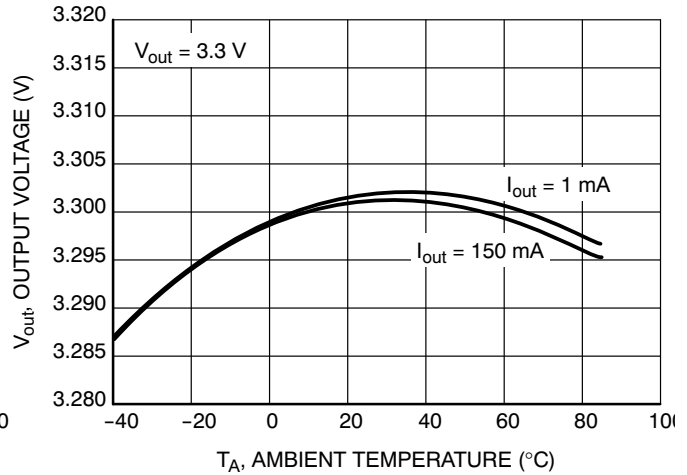

Figure 8. Output Voltage vs. Temperature  
( $V_{out} = 3.3\text{ V}$ )

TYPICAL CHARACTERISTICS

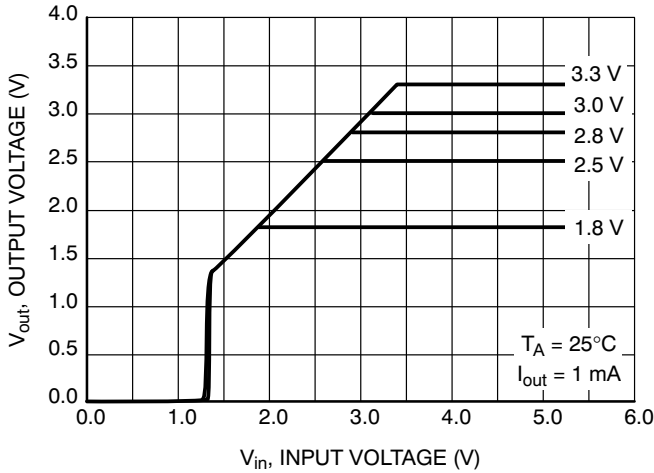

Figure 9. Output Voltage vs. Input Voltage

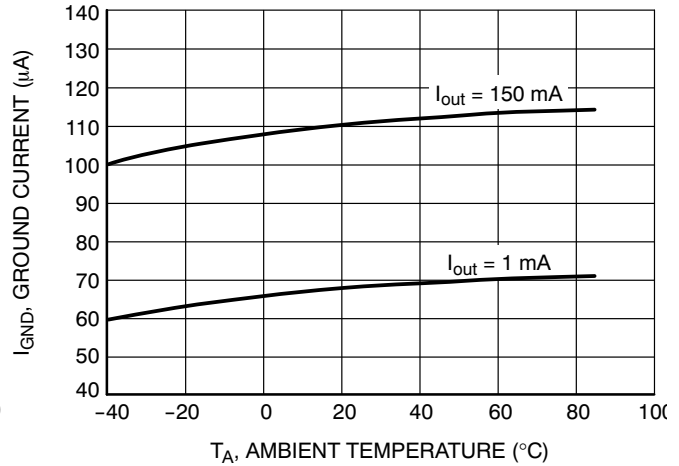

Figure 10. Ground Current vs. Temperature

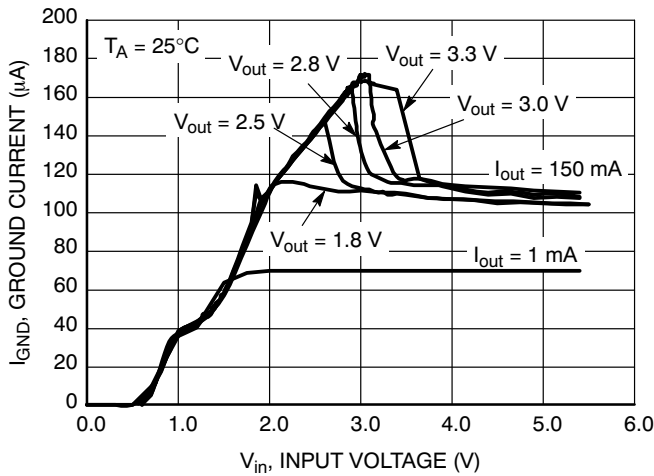

Figure 11. Ground Current vs. Input Voltage

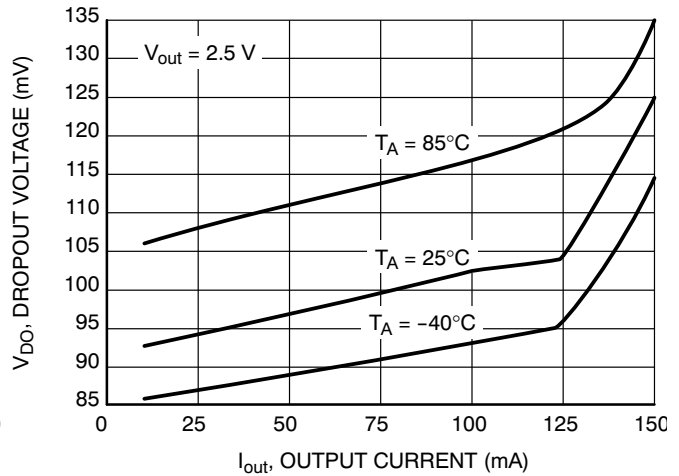

Figure 12. Dropout Voltage vs. Output Current

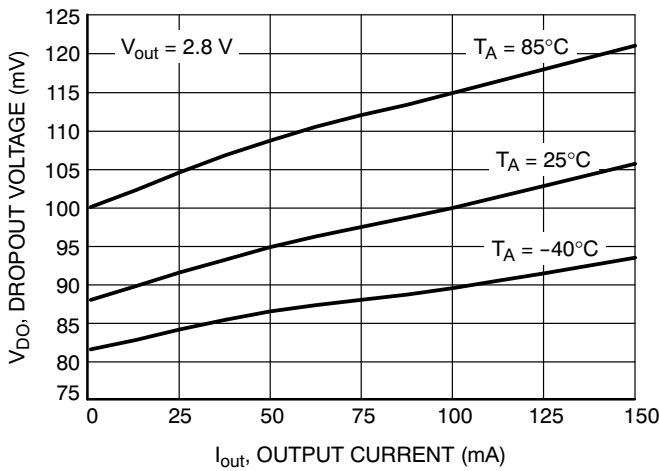

Figure 13. Dropout Voltage vs. Output Current

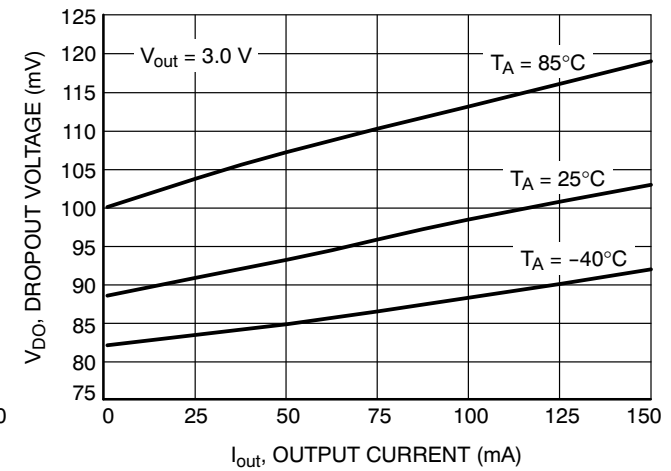

Figure 14. Dropout Voltage vs. Output Current

TYPICAL CHARACTERISTICS

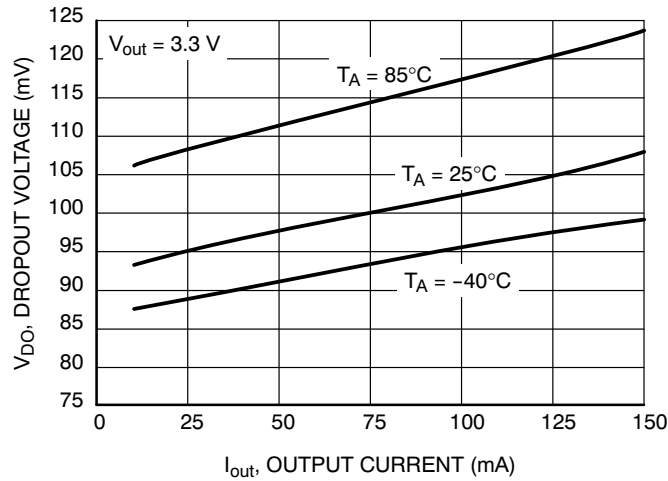

Figure 15. Dropout Voltage vs. Output Current

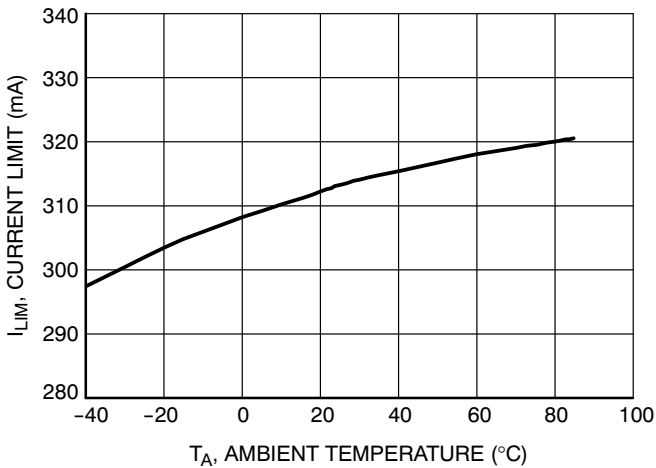

Figure 16. Current Limit vs. Temperature

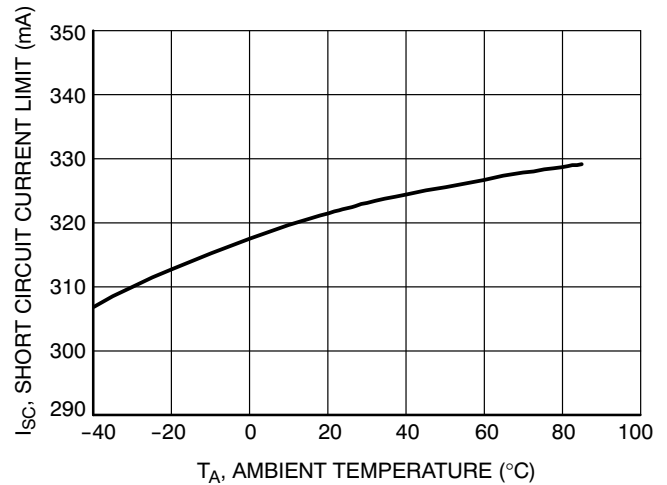

Figure 17. Short Circuit Current vs. Temperature

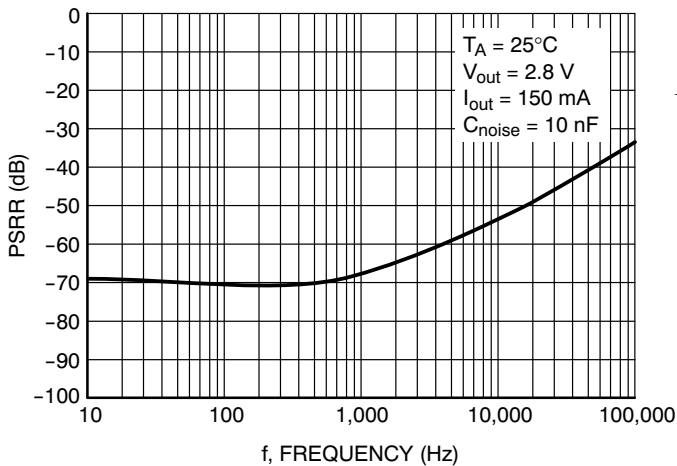

Figure 18. PSRR vs. Frequency

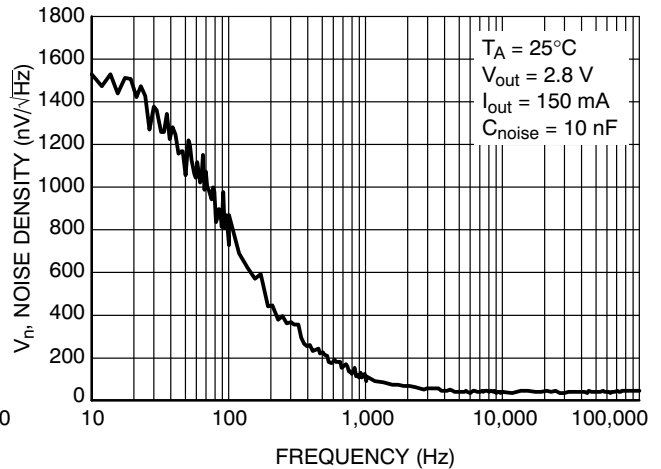
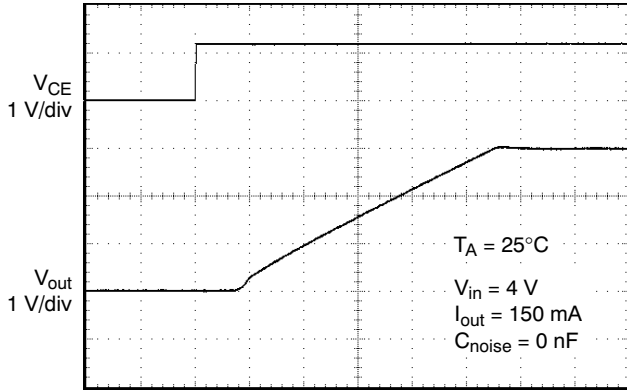

Figure 19. Noise Density vs. Frequency

TYPICAL CHARACTERISTICS



TIME (20  $\mu$ s/div)

Figure 20. Enable Voltage and Output Voltage vs. Time (Start-Up)

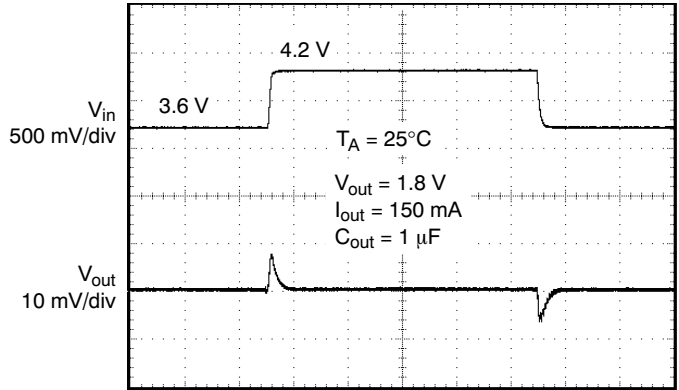

TIME (100  $\mu$ s/div)

Figure 21. Line Transient

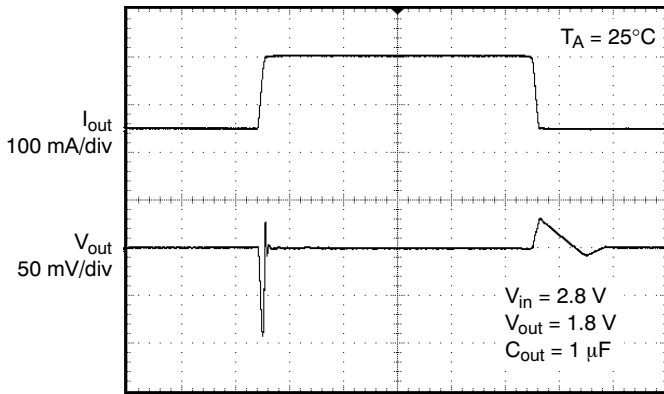

TIME (40  $\mu$ s/div)

Figure 22. Load Transient

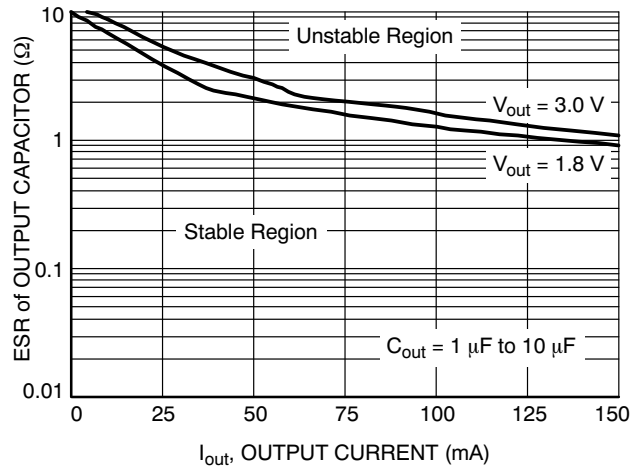

Figure 23. Output Capacitor ESR vs. Output Current

NOTE: Typical characteristics were measured with the same conditions as electrical characteristics, unless otherwise noted.

APPLICATION INFORMATION

**General**

The NCP3985 is a 200 mA (current limited) linear regulator with a logic input for on/off control for the high speed turn-off output voltage.

Access to the major contributor of noise within the integrated circuit is provided as the focus for noise reduction within the linear regulator system.

**Power Up/Down**

During power up, the NCP3985 maintains a high impedance output ( $V_{out}$ ) until sufficient voltage is present on  $V_{in}$  to power the internal bandgap reference voltage. When sufficient voltage is supplied (approx 1.2 V),  $V_{out}$  will start to turn on (assume CE shorted to  $V_{in}$ ), linearly increasing until the output regulation voltage has been reached.

Active discharge circuitry has been implemented to insure a fast turn off time. Then CE goes low, the active discharge transistor turns on creating a fast discharge of the output voltage. Power to drive this circuitry is drawn from the output node. This is to maintain the lowest quiescent current when in the sleep mode ( $V_{CE} = 0.4$  V). This circuitry subsequently turns off when the output voltage discharges.

**CE (chip enable)**

The enable function is controller by the logic pin CE. The voltage threshold of this pin is set between 0.4 V and 1.2 V. A voltage lower than 0.4 V guarantees the device is off. A voltage higher than 1.2 V guarantees the device is on. The NCP3985 enters a sleep mode when in the off state drawing less than 1  $\mu$ A of quiescent current.

The device can be used as a simple regulator without use of the chip enable feature by tying the CE pin to the  $V_{in}$  pin.

**Current Limit**

Output Current is internally limited within the IC to a minimum of 200 mA. The design is set to a higher value to allow for variation in processing and the temperature coefficient of the parameter. The NCP3985 will source this amount of current measured with a voltage 100 mV lower than the typical operating output voltage.

The specification for short circuit current limit (@  $V_{out} = 0$  V) is specified at 320 mA (typ). There is no additional circuitry to lower the current limit at low output voltages. This number is provided for informational purposes only.

**Output Capacitor**

The NCP3985 has been designed to work with low ESR ceramic capacitors. There is no ESR lower limit for stability for the recommended 1  $\mu$ F output capacitor. Stable region for Output capacitor ESR vs Output Current is shown in Figure 23.

Typical characteristics were measured with Murata ceramic capacitors. GRM219R71E105K (1  $\mu$ F, 25 V, X7R, 0805) and GRM21BR71A106K (10  $\mu$ F, 10 V, X7R, 0805).

**Output Noise**

The main contributor for noise present on the output pin  $V_{out}$  is the reference voltage node. This is because any noise which is generated at this node will be subsequently amplified through the error amplifier and the PMOS pass device. Access to the reference voltage node is supplied directly through the  $C_{noise}$  pin. Noise can be reduced from a typical value of 25  $\mu$ V<sub>rms</sub> by using 10 nF to 20  $\mu$ V<sub>rms</sub> by using a 100 nF from the  $C_{noise}$  pin to ground.

A bypass capacitor is recommended for good noise performance and better load transient response.

**Thermal Shutdown**

When the die temperature exceeds the Thermal Shutdown threshold, a Thermal Shutdown (TSD) event is detected and the output ( $V_{out}$ ) is turned off. There is no effect from the active discharge circuitry. The IC will remain in this state until the die temperature moves below the shutdown threshold (150°C typical) minus the hysteresis factor (20°C typical).

This feature provides protection from a catastrophic device failure due to accidental overheating. It is not intended to be used as a substitute for proper heat sinking. The maximum device power dissipation can be calculated by:

$$P_D = \frac{T_J - T_A}{R_{\theta JA}}$$

Thermal resistance value versus copper area and package is shown in Figure 24.

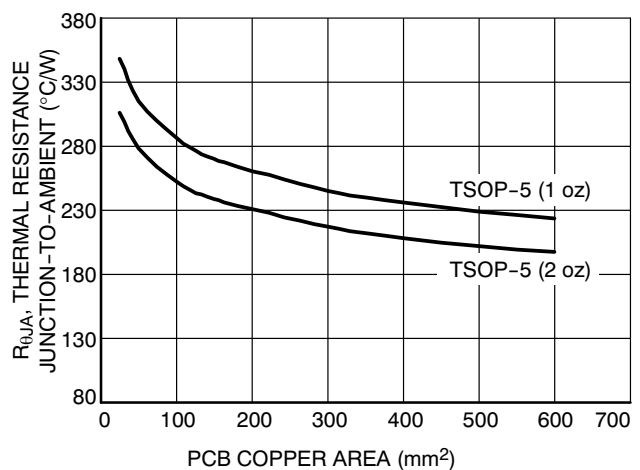

Figure 24.  $R_{\theta JA}$  vs. PCB Copper Area



# NCP3985

## ORDERING INFORMATION

Device	Nominal Output Voltage	Marking	Package	Shipping†
NCP3985SN18T1G	1.8 V	LKA	TSOP-5 (Pb-Free)	3000 / Tape & Reel
NCP3985SN25T1G	2.5 V	LKD		
NCP3985SN275T1G	2.75 V	LKE		
NCP3985SN28T1G	2.8 V	LKB		
NCP3985SN30T1G	3.0 V	LKC		
NCP3985SN33T1G	3.3 V	LKF		

†For information on tape and reel specifications, including part orientation and tape sizes, please refer to our Tape and Reel Packaging Specifications Brochure, BRD8011/D.

# NCP3985

## PACKAGE DIMENSIONS

TSOP-5  
CASE 483-02  
ISSUE H

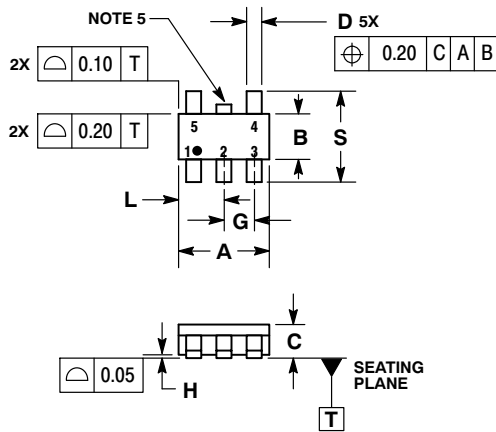

### NOTES:

1. DIMENSIONING AND TOLERANCING PER ASME Y14.5M, 1994.
2. CONTROLLING DIMENSION: MILLIMETERS.
3. MAXIMUM LEAD THICKNESS INCLUDES LEAD FINISH THICKNESS. MINIMUM LEAD THICKNESS IS THE MINIMUM THICKNESS OF BASE MATERIAL.
4. DIMENSIONS A AND B DO NOT INCLUDE MOLD FLASH, PROTRUSIONS, OR GATE BURRS.
5. OPTIONAL CONSTRUCTION: AN ADDITIONAL TRIMMED LEAD IS ALLOWED IN THIS LOCATION. TRIMMED LEAD NOT TO EXTEND MORE THAN 0.2 FROM BODY.

DIM	MILLIMETERS	
	MIN	MAX
A	3.00 BSC	
B	1.50 BSC	
C	0.90	1.10
D	0.25	0.50
G	0.95 BSC	
H	0.01	0.10
J	0.10	0.26
K	0.20	0.60
L	1.25	1.55
M	0°	10°
S	2.50	3.00

### SOLDERING FOOTPRINT\*

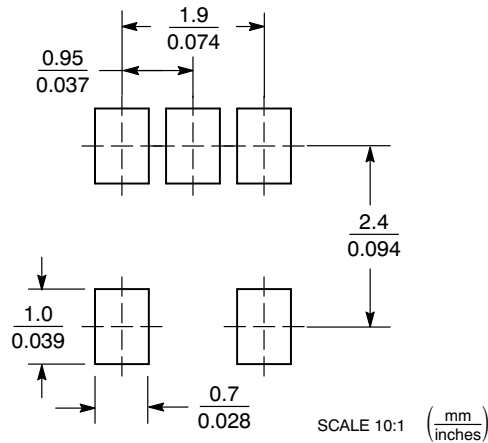

\*For additional information on our Pb-Free strategy and soldering details, please download the ON Semiconductor Soldering and Mounting Techniques Reference Manual, SOLDERRM/D.

The products described herein (NCP3985), may be covered by one or more U.S. patents.

ON Semiconductor and  are registered trademarks of Semiconductor Components Industries, LLC (SCILLC). SCILLC reserves the right to make changes without further notice to any products herein. SCILLC makes no warranty, representation or guarantee regarding the suitability of its products for any particular purpose, nor does SCILLC assume any liability arising out of the application or use of any product or circuit, and specifically disclaims any and all liability, including without limitation special, consequential or incidental damages. "Typical" parameters which may be provided in SCILLC data sheets and/or specifications can and do vary in different applications and actual performance may vary over time. All operating parameters, including "Typicals" must be validated for each customer application by customer's technical experts. SCILLC does not convey any license under its patent rights nor the rights of others. SCILLC products are not designed, intended, or authorized for use as components in systems intended for surgical implant into the body, or other applications intended to support or sustain life, or for any other application in which the failure of the SCILLC product could create a situation where personal injury or death may occur. Should Buyer purchase or use SCILLC products for any such unintended or unauthorized application, Buyer shall indemnify and hold SCILLC and its officers, employees, subsidiaries, affiliates, and distributors harmless against all claims, costs, damages, and expenses, and reasonable attorney fees arising out of, directly or indirectly, any claim of personal injury or death associated with such unintended or unauthorized use, even if such claim alleges that SCILLC was negligent regarding the design or manufacture of the part. SCILLC is an Equal Opportunity/Affirmative Action Employer. This literature is subject to all applicable copyright laws and is not for resale in any manner.

### PUBLICATION ORDERING INFORMATION

**LITERATURE FULFILLMENT:**  
Literature Distribution Center for ON Semiconductor  
P.O. Box 5163, Denver, Colorado 80217 USA  
Phone: 303-675-2175 or 800-344-3860 Toll Free USA/Canada  
Fax: 303-675-2176 or 800-344-3867 Toll Free USA/Canada  
Email: orderlit@onsemi.com

**N. American Technical Support:** 800-282-9855 Toll Free  
USA/Canada  
**Europe, Middle East and Africa Technical Support:**  
Phone: 421 33 790 2910  
**Japan Customer Focus Center**  
Phone: 81-3-5773-3850

**ON Semiconductor Website:** [www.onsemi.com](http://www.onsemi.com)

**Order Literature:** <http://www.onsemi.com/orderlit>

For additional information, please contact your local Sales Representative